

L190S SHIELDED LEVEL FLOAT SWITCH

INSTALLATION AND OPERATIONS MANUAL

Single-Point, Vertically-Mounted,
Shielded Liquid Level Float Switch



SOLUTIONS WITH INNOVATION

AN INNOVATIVE SENSING COMPANY

ISO 9001:2008 CERTIFIED

This manual provides information on the **L190S Shielded Liquid Level Float Switch**. It is important that all instructions are read carefully and followed sequentially. Detailed instructions are included in the **Complete Installation** section of this manual.

Conventions Used in this Manual

Certain conventions are used in this manual to convey specific types of information. General technical material, support data and safety information are presented in narrative form. The following styles are used for notes, cautions and warnings:

Notes

Notes contain information that augments or clarifies an operating step. Notes do not normally contain actions and often follow the procedural steps to which they refer.

Cautions

Cautions alert the technician to special conditions that could injure personnel, damage equipment, or reduce a component's mechanical integrity. Cautions are also used to alert the technician of unsafe practices, the need for special protective equipment, or specific materials. In this manual, a caution indicates a potentially hazardous situation which, if not avoided, may result in minor to moderate injury.

Notice of Copyright and Limitations

Copyright © 2015 Solutions With Innovation, LLC;
All rights reserved.

Solutions With Innovation reserves the right to make changes to the product described in this manual at any time without notice. Solutions With Innovation makes no warranty with respect to the accuracy of the information in this manual.

Warranty

All Solutions With Innovation Mechanical Level and Flow Controls are warranted free of defects in materials and workmanship for one full year from the date of the original factory shipment. If returned within the warranty period; and, upon factory inspection of the control, the cause of the claim is determined to be covered under the warranty; then, Solutions With Innovation will repair or replace the product at no cost to the purchaser (or owner) other than transportation.

Solutions With Innovation shall not be liable for misapplication, labor claims, direct or consequential damage, or expenses arising from the installation or use of the equipment. There are no other warranties expressed or implied, except special written warranties covering specific Solutions With Innovation products.

Quality Assurance

The Quality Assurance System in place at Solutions With Innovation guarantees the highest level of quality throughout the company. Solutions With Innovation is committed to providing full customer satisfaction; both in quality products and in quality service.

Contacts

Phone: 203-729-6434 *Mon-Fri, 9 AM - 5 PM EST*
Fax: 203-729-0541 *for General Inquiries*
Email: sales@innovativesensing.com

L190S SHIELDED LEVEL FLOAT SWITCH

Single-Point, Vertically-Mounted

TABLE OF CONTENTS

1.0 Installation

1.1 Unpacking.....	4
1.2 Before You Begin.....	4
1.2.1 Site Preparation.....	4
1.2.2 Equipment and Tools.....	4
1.3 Mounting.....	5
1.4 Wiring.....	5

2.0 Preventative Maintenance

2.1 What To Do.....	6
2.1.1 Inspect Entire Unit Periodically.....	6
2.1.2 Inspect Connections Monthly.....	6
2.1.3 Keep Unit Clean.....	6
2.2 What To Avoid.....	6

3.0 Reference Information

3.1 Description.....	7
3.2 Theory of Operation.....	7
3.3 Troubleshooting.....	7
3.3.1 External Causes.....	7
3.3.2 Unit Causes.....	8
3.4 Agency Approvals.....	9
3.5 Specifications.....	9
3.5.1 Physical Specifications.....	9
3.5.2 Electrical Specifications.....	9
3.5.3 Replacement Parts.....	9
3.5.4 Dimensional Specifications.....	10
3.6 Model Configurator.....	10
3.7 Notes.....	11



1.0 INSTALLATION

This section provides detailed procedures on properly installing the L190S Shielded Liquid Level Float Switch.

 **CAUTION!** IF THE EQUIPMENT IS USED IN A MANNER NOT SPECIFIED BY THE MANUFACTURER, PROTECTION PROVIDED BY THE EQUIPMENT MAY BE IMPAIRED.

 **CAUTION!** THIS UNIT CONTAINS REED SWITCHES THAT MAY BE PERMANENTLY DAMAGED BY MECHANICAL SHOCK OR VIBRATION. AVOID DROPPING OR HITTING THE DEVICE AGAINST HARD SURFACES.

1.1 UNPACKING

Unpack the instrument, carefully. Make sure that all components have been removed from the packing material. Inspect all components for damage. Report any concealed damage to the carrier within 24 hours of receiving. Compare the contents with the packing slip and report any discrepancies to the factory immediately. Record the sales order number and/or serial number for future reference when ordering parts.

Before Proceeding to Installation, Complete the Following:

- Inspect all components for damage. Report any damage to the carrier within 24 hours of receiving.
- Record the model and serial numbers for future reference when ordering parts.

Model Number _____

Serial Number _____

1.2 BEFORE YOU BEGIN

 **CAUTION!** DURING THE INSTALLATION OF THE L190S SHIELDED LIQUID LEVEL SWITCH, THE FLOAT AREA MUST BE KEPT FREE OF METALLIC PARTICLES THAT MIGHT BE ATTRACTED TO THE FLOAT'S INTERNAL MAGNET.

1.2.1 Site Preparation

- 1 Ensure that the mounting is sized correctly to accommodate the L190S Shielded Liquid Level Float Switch.

1.2.2 Equipment and Tools

No special equipment or tools are required to install the L190S Shielded Liquid Level Float Switch..

The Following Are Recommended:

- Wrenches and/or bolting as required for the mount and process connection.

1.3 MOUNTING

The L190S Shielded Liquid Level Float Switch is equipped with an easy installation bracket mount.

Installing the L190S Shielded Liquid Level Float Switch:

- 1 Mark the intended location of the switch on the equipment. Make a dot where each bracket hole is located for easy alignment.
- 2 Verify that the unit is oriented as vertical as possible to ensure optimum level sensing.
- 3 Mount the switch into place by inserting bolts through the bracket holes and tank wall.
- 4 Twist a nut and washer onto the opposing side of the tank wall and tighten to secure the switch.

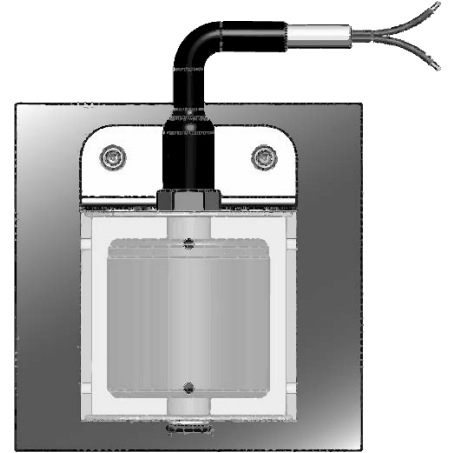

⚡ CAUTION! DO NOT OVERTIGHTEN AS DAMAGE CAN OCCUR TO THE BRACKET HOLES OR TO THE SWITCH ITSELF.

- 5 Route the cable to prevent any possible damage.
- 6 Test the equipment to ensure proper functioning.

1.4 WIRING

⚡ CAUTION! OBSERVE ALL APPLICABLE ELECTRICAL CODES AND PROPER WIRING PROCEDURES.

SPST Reed Switch:

- 1 Connect the wiring to the switch leads or terminals, as illustrated below.

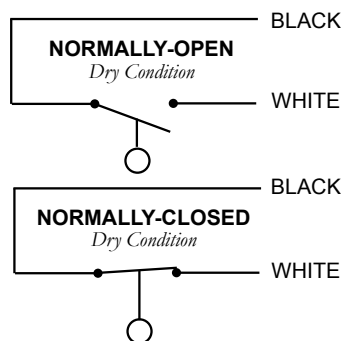

SPDT Reed Switch:

- 1 Connect the wiring to the proper switch leads or terminals, as illustrated below.

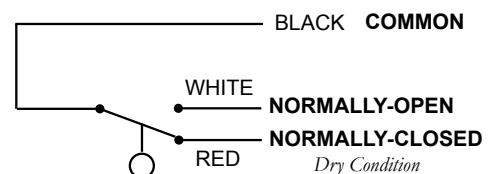

Contact Protection:

In order to maintain the life and reliability of the internal reed switch, it is essential to provide protection when switching inductive loads. When the current breaks, the energy stored in the load generates a high frequency voltage across the switch contacts. If the voltage is large enough, it can initiate arcing and cause the contacts to weld together. The use of a diode for DC circuits and a resistor-capacitor network for AC circuits, contact protection will ensure reliable performance from the reed switch.

2.0 PREVENTATIVE MAINTENANCE

Periodic inspections are necessary to maintain the proper functionality of the L190S Shielded Liquid Level Switch. The switch is a safety device that protects the equipment it serves. A systematic program of preventative maintenance should be implemented at the time of installation. If the following instructions are completed routinely, the switch will provide continuous, reliable protection.

2.1 MAINTENANCE PROCEDURES

2.1.1 Inspect Unit Periodically

Verify that there are no cracks or chipped surfaces on the shield. Should the unit become damaged, obtain a replacement immediately.

2.1.2 Inspect Connections Monthly

L190S Shielded Liquid Level Switches may be vulnerable to excessive heat and moisture. Under these conditions, the electrical wire insulation can periodically break or peel away. As a result, the bare wires may become exposed to the elements and incur damages.

- Inspect all wiring, carefully and replace any wires exhibiting signs of brittle insulation.
- Inspect all electrical connections to ensure tightness.
- Repair or replace any wiring, if necessary.

2.1.3 Keep Unit Clean

Periodic cleanings of the float and stem assembly will ensure the continual, uninterrupted movement of the mechanism. Always keep the open area between the enclosures clean and free of any potential interferences. Objects and debris may cause systematic interruptions and a loss in equipment functionality.

2.2 WHAT TO AVOID



NEVER LEAVE THE SWITCH WIRING EXPOSED TO THE ELEMENTS.



NEVER PLACE A JUMPER WIRE ACROSS THE TERMINALS TO “CUT-OUT” THE CONTROL. *If a jumper is necessary for testing purposes, ensure that it is removed prior to placing the control into service.*



NEVER USE IN SYSTEMS CONTAINING IRON PARTICLES. *The magnet within the float assembly can attract the particles and become jammed.*

3.0 REFERENCE INFORMATION

This section illustrates an overview of the L190S Shielded Liquid Level Switch, as well as information on troubleshooting common problems, agency approval listings, and detailed physical, functional and performance specifications.

3.1 DESCRIPTION

The L190S Shielded Liquid Level Switch is a float-actuated device designed to be vertically-mounted within a tank or process vessel through bracket connections. The low-cost switch is ideal for OEM applications where single-point level alarms are desired.



3.2 THEORY OF OPERATION

The switching action is achieved through the use of an internal magnet within the float assembly and its interaction with the switch mechanism. As the liquid level fluctuates inside the tank, the float moves. Its magnetic field actuates the switch inside the stem, completing an electrical circuit.

3.3 TROUBLESHOOTING

The L190S Shielded Liquid Level Switch is designed and engineered for trouble-free operation over a wide range of operating conditions. Common problems are discussed in terms of their symptoms and recommended corrective actions.

3.3.1 External Causes

An initial indication of improper operation is the failure of the controlled equipment to function (pumps will not start or stop, signal lamps fail to light, etc). If these symptoms occur, whether at the time of installation or during routine service thereafter, check for potential external causes first:

- Blown Fuses
- Tripped Reset Button(s)
- Open Power Switch
- Faulty Equipment Controlled By the Level Switch
- Defective Wiring to the Level Switch

3.3.2 Unit Causes

If a thorough inspection of any external causes fails to locate the problem, proceed to an inspection of the unit, itself. **DISCONNECT POWER TO THE LEVEL SWITCH BEFORE PROCEEDING.**

SYMPTOM	PROBLEM	SOLUTION
THE UNIT IS UNRESPONSIVE.	ELECTRICAL FAILURE.	USE AN ELECTRICAL CONTINUITY CHECKER TO DETERMINE IF THE SWITCH IS FUNCTIONAL. IF THE SWITCH DOES NOT OPERATE PROPERLY WHEN ACTIVATED, THE ENTIRE LEVEL SWITCH MUST BE REPLACED.
THE UNIT DOES NOT ACTIVATE WHEN THE FLOAT CHANGES POSITION.	THE UNIT IS JAMMED.	REMOVE THE LEVEL SWITCH FROM SERVICE. CHECK THE FLOAT ASSEMBLY FOR OBSTRUCTIONS OR ACCUMULATION OF PARTICLES WHICH MAY CAUSE BINDING. IF BINDING IS PRESENT IN THE FLOAT ASSEMBLY AND CANNOT BE CLEARED BY NORMAL CLEANING PROCEDURES, THE ENTIRE CONTROL MUST BE REPLACED.
THE UNIT ONLY FUNCTIONS WHEN IT IS NOT IN SERVICE.	LIQUID IS NOT ENTERING THE VESSEL.	CHECK TO ENSURE THAT LIQUID IS ENTERING THE TANK OR VESSEL. A CLOSED VALVE OR CLOGGED PIPELINE MAY PREVENT MOVEMENT OF THE LIQUID IN THE VESSEL.
THE UNIT ONLY FUNCTIONS WHEN IT IS NOT IN SERVICE.	THE TANK LEVEL IS NOT HIGH ENOUGH TO HAVE THE FLOAT FUNCTION.	CHECK THE FLOAT TO MAKE SURE IT IS BUOYANT IN THE LIQUID. THE TANK OR VESSEL MUST HAVE AN ADEQUATE LIQUID LEVEL.
THE FLOAT IS NOT BUOYANT.	THE FLOAT IS COLLAPSED AND/OR FILLED WITH LIQUID.	CHECK THE FLOAT FOR RUPTURES, DEFORMATION, AND ANY LIQUID TRAPPED INSIDE THE ASSEMBLY. IF THE FLOAT IS FILLED WITH LIQUID OR HAS COLLAPSED, THE ENTIRE LEVEL SWITCH MUST BE REPLACED. DO NOT ATTEMPT TO REPAIR THE FLOAT.
ALL COMPONENTS WITHIN THE LEVEL SWITCH ARE IN WORKING ORDER, BUT THE UNIT STILL DOES NOT FUNCTION.	AN EXTERNAL PROBLEM.	REPEAT AN INSPECTION OF THE EXTERNAL CONDITIONS AS DESCRIBED IN SECTION 3.3.1.

 *If you are still in doubt about the condition or performance of your control, consult the factory for further instructions.*

3.4 AGENCY APPROVALS

AGENCY	APPROVED MODEL(S)	FILE NUMBER	AREA CLASSIFICATION
UL 	L190	E203716	RECOGNIZED UNDER UL508 MOTOR CONTROLLERS & NJ0T8 MOTOR CONTROLLERS

3.5 SPECIFICATIONS

3.5.1 Physical Specifications

FLOAT MATERIAL	DIMENSIONS	TEMPERATURE	PRESSURE	MIN. SPECIFIC GRAVITY
316 Stainless Steel	1.50" x 1.30"	-40° to +250° F	120 PSIG	0.80
Buna-N	1.875" x 1.75"	-40° to +180° F	150 PSIG	0.57

3.5.2 Electrical Specifications

SIGNAL OUTPUT	Switch Closure
TYPE OF CONTACTS	SPST, SPDT
TYPE OF SWITCHES	Hermetically-Sealed Reed Switch
SWITCH RATING	50 VA, 240 VAC/VDC Max. SPST
	100 VA, 240 VAC/VDC Max. SPST
	20 VA, 240 VAC/VDC Max. SPDT
CABLING	24" Long, 18 AWG UL-Approved Cable

3.5.3 Replacement Parts

When Ordering, Please Specify:

- Model & Serial Numbers
- Name & Part Number of Replacement Part or Assembly

Contact the manufacturer for ordering assistance on all replacement parts. There are several options to choose from. *Call 203-729-6434.*

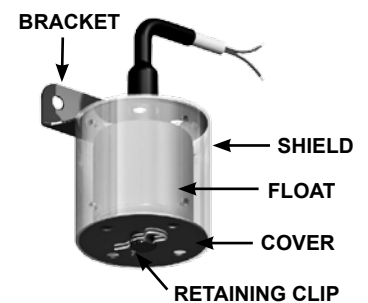

3.5.4 Dimensional Specifications

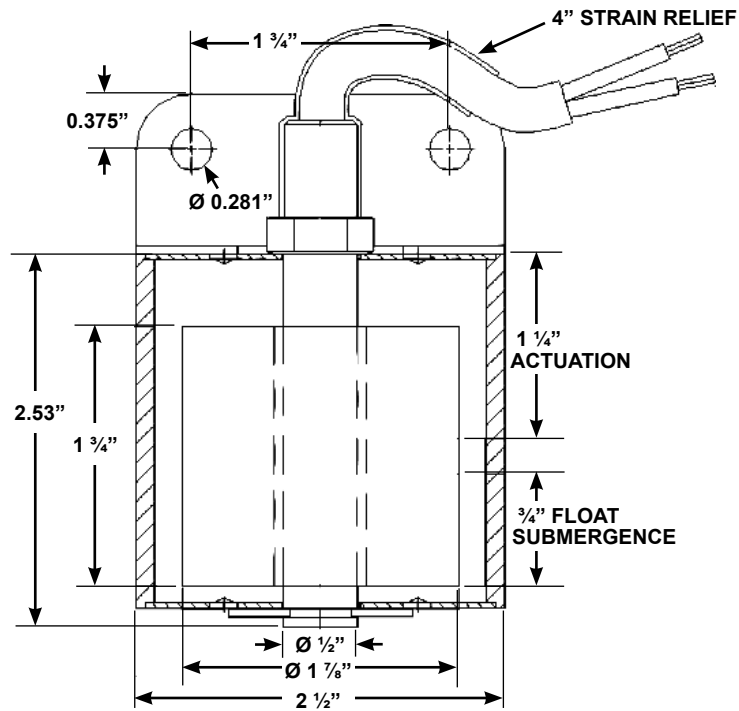

3.6 MODEL CONFIGURATOR

TECHNOLOGY		MODEL		CONFIG.		MOUNT		STEM		FLOAT		ELECTRICAL		MEDIA SG.		SHIELD	
L	Liquid Level Sensor	190	1/2" Dia. Stem	S	Shielded	B	Bracket	08	316 S.S.	08	316 S.S.	03	50 VA SPST	SG	Contact Us	08	316 S.S.
				C	Custom	C	Custom			20	Buna-N	04	100 VA SPST			23	Polycarbonate
												14	20 VA SPDT				

L	1	9	0	S	B	0	8	-	0	8	0	3	-	1	2	-	0	8
---	---	---	---	---	---	---	---	---	---	---	---	---	---	---	---	---	---	---

3.7 NOTES

ASSURED QUALITY & SERVICE COST LESS

Service Policy

Owners of Solutions With Innovation products may request a return of the product, or any part of the product for complete rebuilding or replacement. Units will be rebuilt or replaced promptly. Products returned under the SWI Service Policy must be returned by prepaid transportation. Solutions With Innovation will repair or replace the product at no cost to the purchaser (or owner) other than transportation if:

- 1 Returned within the warranty period; and
- 2 Factory Inspection finds the cause of the claim to be covered under the warranty.

If the problem is due to circumstances beyond Solutions With Innovation's liability, or is NOT covered by the warranty, there will be charges for labor in addition to the parts required to rebuild or replace the equipment.

In rare cases, it may be expedient to ship replacement parts; or in extreme cases, an entire product before the damaged product is returned. If a quick replacement service is necessary, notify the manufacturer of the damaged product's model and serial number. In such cases, credit for the returned materials will be determined on the applicability of the warranty.

No claims for misapplication, labor, direct or consequential damage will be allowed.

Return Material Procedure

In order to efficiently process any returned materials, it is essential that a *Return Material Authorization* (RMA) number be obtained from the manufacturer prior to an item's return. RMA's can be issued through local representatives, or by contacting the factory directly.

Please supply the following information:

- 1 The Company's Name
- 2 Description of the Material
- 3 Product Serial Number
- 4 Reason for Return
- 5 Product's Application

Used units must be properly cleaned in accordance with OSHA standards before it is returned to the manufacturer. A *Material Safety Data Sheet* (MSDS) must accompany units or materials that were used in any type of media. All return shipments to the factory must be by done via prepaid transportation. All product replacements will be shipped F.O.B. manufacturer.



SOLUTIONS WITH INNOVATION

AN INNOVATIVE SENSING COMPANY

ISO 9001:2008 CERTIFIED

BULLETIN: IS-9160.2
EFFECTIVE: 1/15

